

# Electromagnetic Lock Installation Instruction (Indoor Series)

## Specifications

Model	Holding Force	Current Draw	Optional Bracket
EM-150 Series	300 lbs(136 Kg)	350mA@12VDC 170mA@24VDC	
10001 Series	600 lbs(272 Kg)	500mA@12VDC 250mA@24VDC	L-300, EM-10001L bracket for narrow door frames. LZ-300, LZ-300N, EM-10001LZ bracket for in-swinging doors.
EM-300 Series	600 lbs (272 Kg)	500mA@12VDC 250mA@24VDC	EM-300L bracket for narrow door frames. EM-300LZ bracket for in-swinging doors.
10004 Series	600 lbsX2 (272 KgX2)	500mA@12VDCX2 250mA@24VDCX2	L-300, EM-10001L bracket for narrow door frames. LZ-300N, EM-10001LZ bracket for in-swinging doors.
EM-350 Series	800 lbs (363 KgX2)	500mA@12VDC 250mA@24VDC	L-350 bracket for narrow door frames. LZ-350 bracket for in-swinging doors.
10010 Series	1200 lbs (545 Kg)	500mA@12VDC 250mA@24VDC	L-500 bracket for narrow door frames. LZ-500, LZ-500N bracket for in-swinging doors.
10060 Series	1200 lbsX2 (545 KgX2)	500mA@12VDCX2 250mA@24VDCX2	L-500 bracket for narrow door frames. LZ-500N bracket for in-swinging doors.

## Holding Force Curve & Accessories

The holding force of the electromagnetic lock is depending on the voltage of the power supply. The graph below illustrates the change of the holding force under different voltage. The holding forces of the electromagnetic lock used here by the manufacture here "Colinear" force.

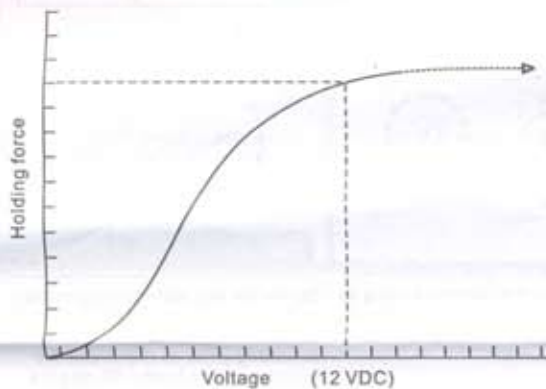

Please note that the actual accessory pack varies according to the electromagnetic lock model.

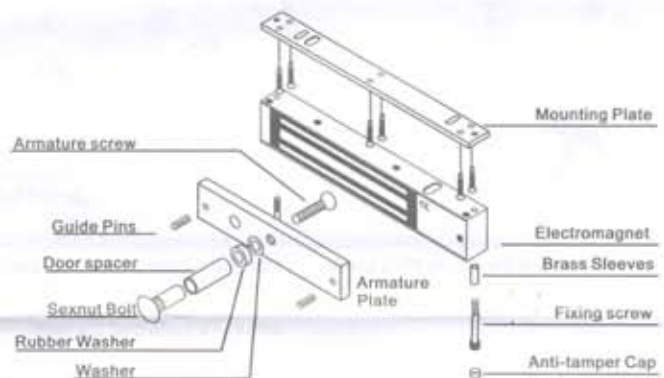

## Optional Bracket

Identify the door swinging direction and inspect the door frame header to determine if bracket is required. A L- bracket, LZ- bracket or U- bracket(optional) may be required for the electromagnet depending on the frame header and swinging direction.

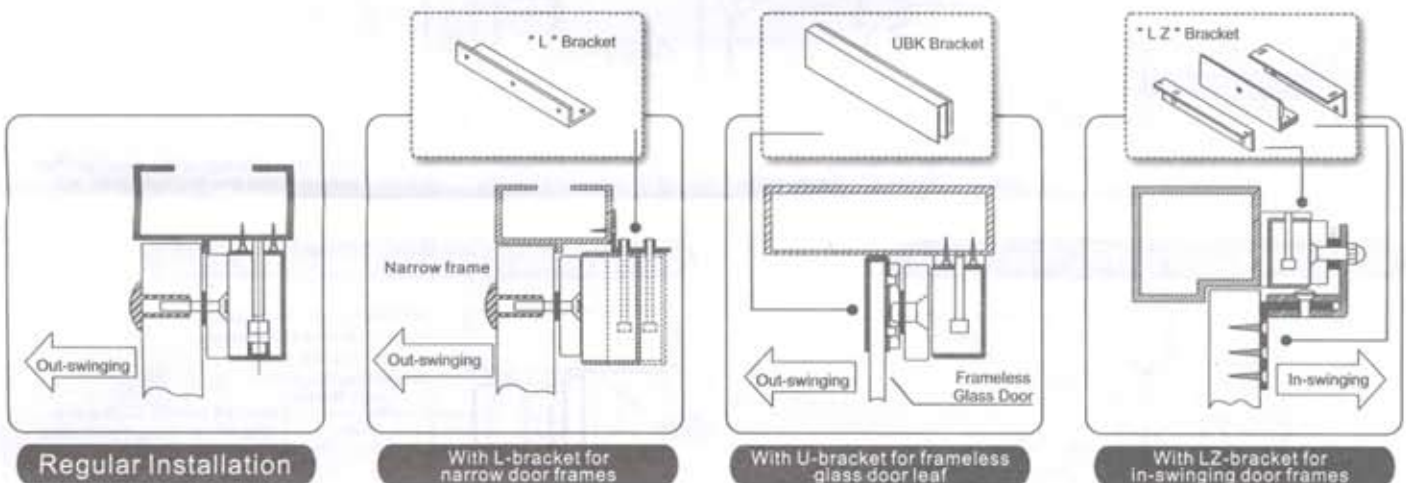

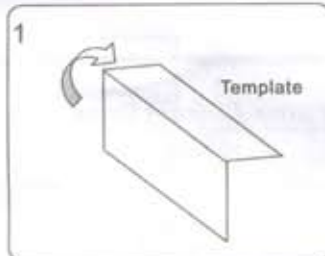

1 Fold the mounting template along the dotted line to a 90-degree angle.

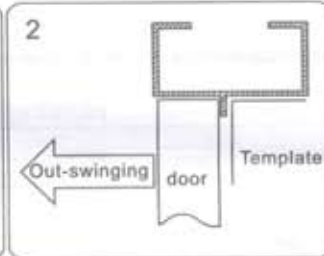

2 Close the door, find a mounting location on the door frame near the upper free-moving corner of the door, as close to the corner of the door frame as possible.

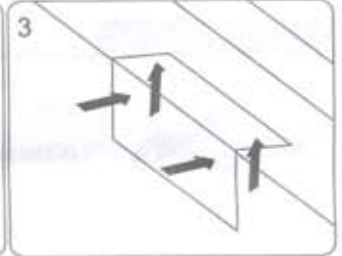

3 Place the template against the door and frame. Drill two holes in the frame and three holes in door as indicated on the template.

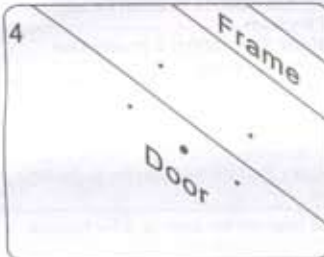

4 Drill two holes in the frame and three holes in the door as indicated on the template.

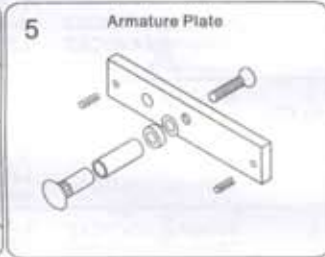

5 Mounting the armature plate to the door. Actual installation varies according to door style.

Hollow Metal Door

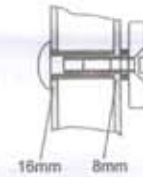

Drill an 8 mm hole through door, from sexnut bolt side only, enlarge the 8mm hole to 16mm.

Solid Door



Drill an 8 mm hole thru door from sexnut bolt side of door, drill 12.7mm hole, 36mm in depth.

Reinforced Door



Drill an 6.8 mm dia. Hole and tap for M8x12.5 thread.

**Recommendation:**  
 Micro EM-locks (300 LBS) maximum thickness of door is 44 mm.  
 Mini EM-locks (600 LBS) maximum thickness of door is 50 mm.  
 Midi EM-locks (800 LBS) maximum thickness of door is 48 mm.  
 Standard EM-locks (1200 LBS) maximum thickness of door is 46 mm.

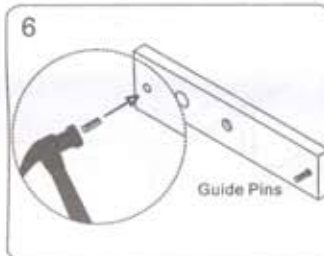

6 Make sure the Guide Pins are in the two guide pin holes.

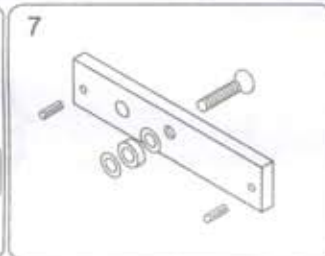

7 Put one rubber washer between two washers, and place them over the armature screw between the armature plate and the door.



8 This will allow the armature plate to pivot slightly around the armature screw in order to compensate for door misalignment.

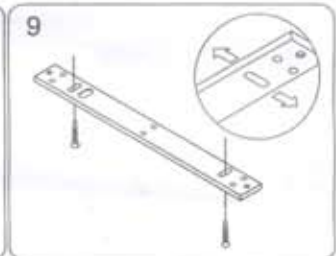

9 Screw the two self-tapping screws in the slotted holes of the mounting plate and adjust the position of the mounting plate so that it and the armature plate from a 90-degree angle.

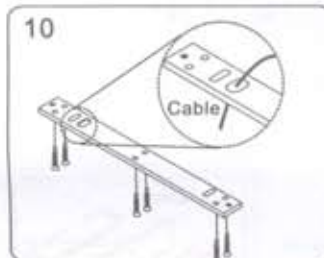

10 Once the position is correct, use the screws to permanently mount the mounting plate. And drill the cable access hole.

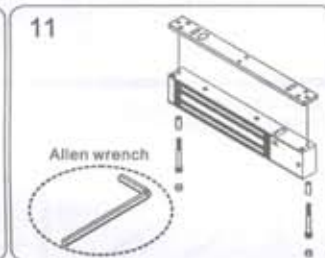

11 Use the Allen wrench to screw the Fixing screws and Brass Sleeves through the bottom of the electromagnet into the mounting plate.

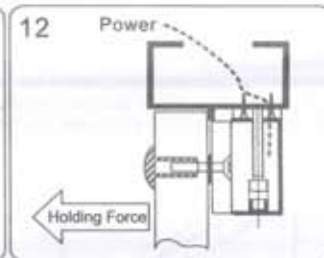

12 Connect the power lead, and test the unit.

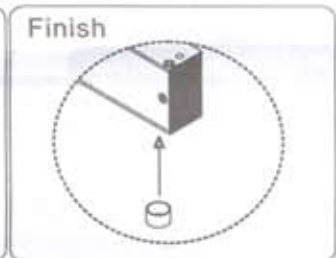

13 Insert the anti-tamper caps into the mounting screw access holes. This should be the last step, as once the tamper caps are in place, they will be difficult to remove.

With L bracket for narrow door frames

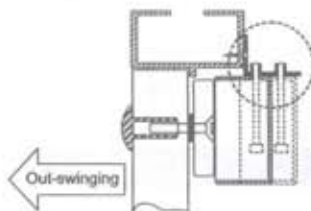

L bracket is used as extension on narrow door frames to provide adequate mounting surface.

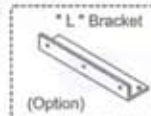

With U bracket for frameless glass doors

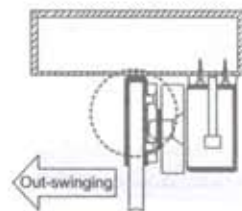

Universal glass door kits are compatible with lock models, except 1200 lbs serial.

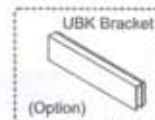

UBK-008 for 8mm of glass door  
 UBK-010 for 10mm of glass door  
 UBK-012 for 12mm of glass door  
 UBK-014 for 14mm of glass door



**With LZ bracket for In-swinging doors**

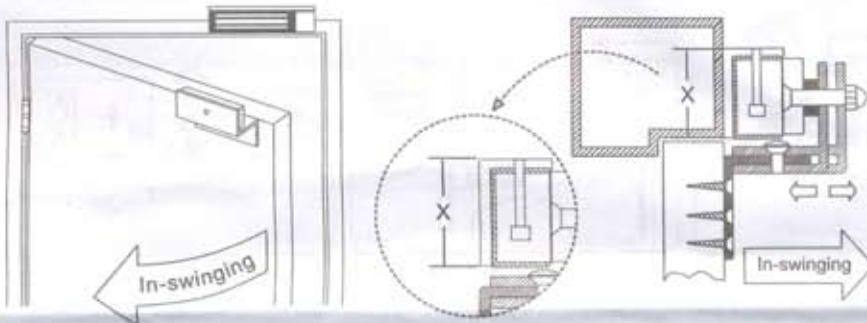

The "X" value in the table below for each bracket to mount on the door frame, shows the minimum requirement width of the door frame for different electromagnetic lock model.

Model	"X" value
300 lbs serial	-----
600 lbs serial	48mm
800 lbs serial	54mm
1200 lbs serial	76mm

**Installation Steps of LZ bracket for In-swinging doors**

**1**

Find a mounting location on the door frame for the L bracket, and place them over the 8mm armature screw.

**2**

Tighten the electromagnetic lock on the L bracket by using the fixing screw.

**3**

Assemble the Z bracket, and make sure that the Z bracket is adjustable.

**4**

Insert the guide pins into the armature plate. The guide pins will prevent the armature plate to pivot around.

**5**

Put one rubber washer between armature plate and the Z bracket, and place them over the 8mm armature screw.

**6**

Close the door. Measure the correct position by bringing the armature plate close to the contact surface of the electromagnetic lock.

**7**

Turn on the power of EM-Lock, and let the armature plate bonds to the EM-lock. Adjust the position between the Z bracket and the door frame.

**Finish**

Once the position is correct, use the screws to permanently mount the Z bracket on the door frame. This should be the last step.

**Connecting Diagram**

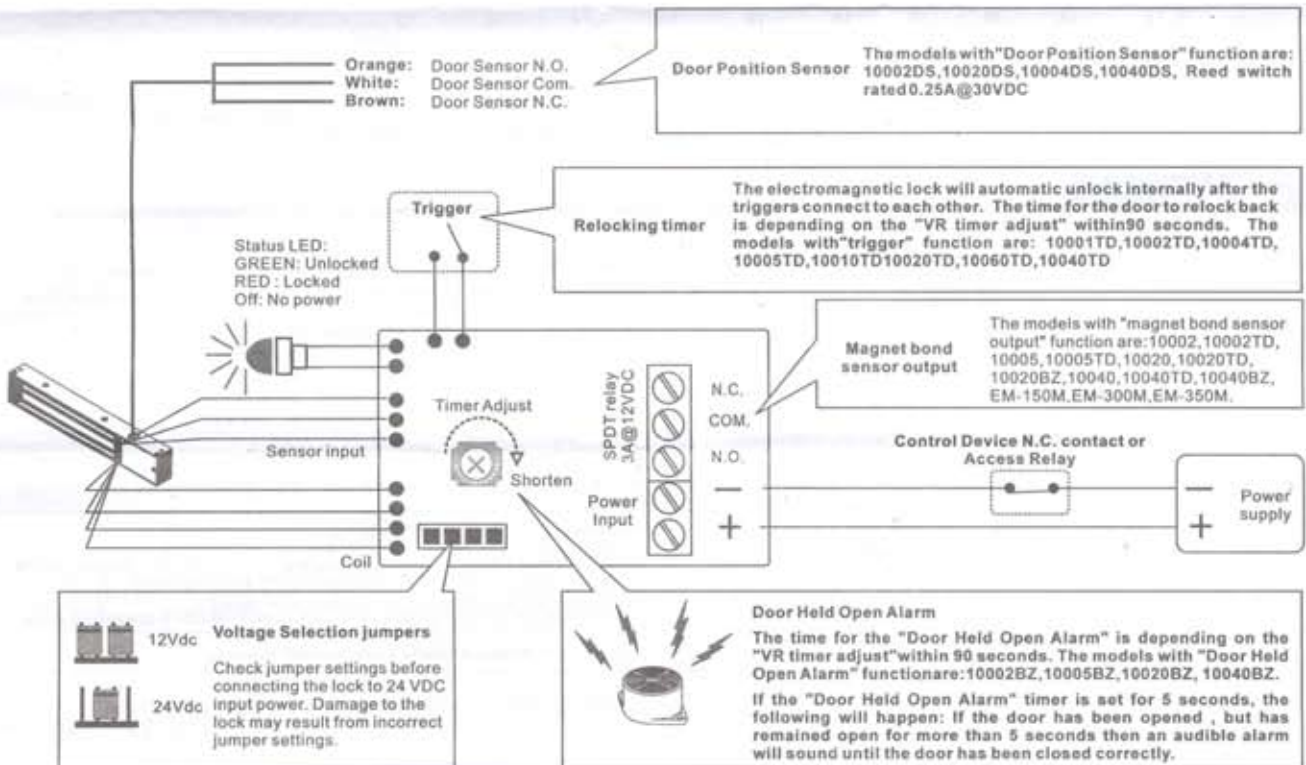

## Important Notes

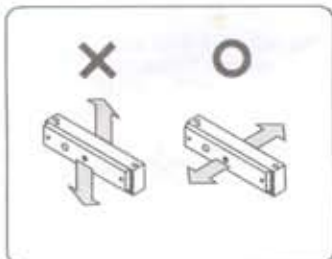

During the installation procedure, it is important to make sure that the working direction of the armature plate has to be facing toward the contact surface of the electromagnetic lock intend to have the maximum holding force.

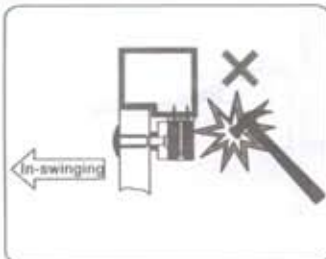

Be aware that it is better to install the electromagnetic lock inside the house and hide the cable inside the door frame in order to against the unlawful entry.

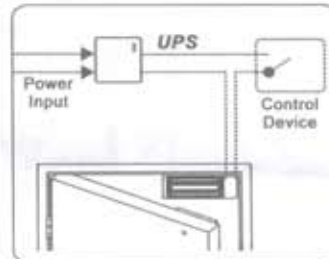

The electromagnetic locks are fail-safe and will require a power supply equipped with battery back up when power outages may interfere with desired security.

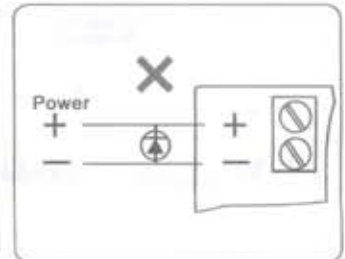

Do not install a diode in parallel with any magnetic lock. A diode will cause a delay when releasing the door and residual magnet to occur.

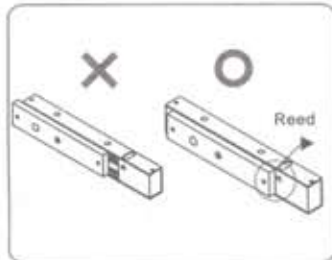

The contact surface of the electromagnetic lock and the armature plate has to be completely attached; otherwise, the reed, which located inside the electromagnetic lock, will not be detected. It will result an incorrect output message for the bond sensor.

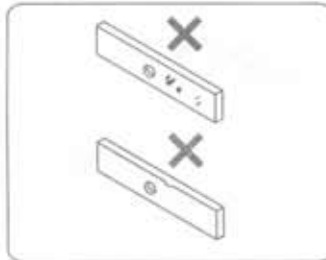

Damage to the mating surfaces may reduce the efficiency of the lock and cause rust.

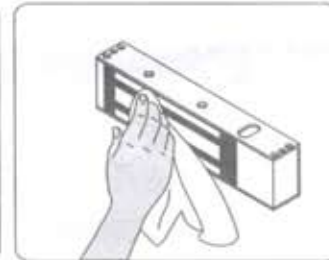

Apply a light coat of a silicon lubricant to prevent rust. Wipe away the excess.

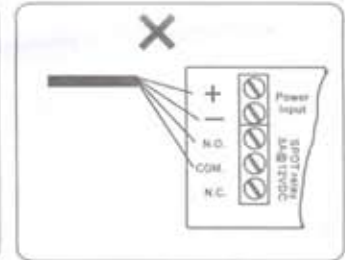

Do not run power wires and signal wire in the same cable or conduit.

## Distance in feet from power source to farthest locking device

	AMPS	25f	50f	75f	100f	150f	200f	250f	300f	400f	500f	1000f
Minimum Wire Gauge for 12 VDC	0.25	18	18	18	18	18	16	16	14	14	12	
	0.50	18	18	18	16	16	14	12				
	0.75	18	18	16	14	12	12					
	1.00	18	16	14	14	12						
	1.50	18	14	12	12							
2.00	16	14	12									
Minimum Wire Gauge for 24 VDC	0.25	18	18	18	18	18	18	18	18	16	16	16
	0.50	18	18	18	18	18	16	16	14	14	12	
	0.75	18	18	18	18	16	14	14	12	12		
	1.00	18	18	16	16	14	14	12	12			
	1.50	18	18	16	14	14	12					
2.00	16	16	14	14	12							

## Trouble Shooting

Problem	Possible Cause	Solution
Door does not lock	No power	Check to make sure the wires are securely tightened to the correct terminal block
		Check that the power supply is connected and operating properly
		Make sure the lock switch is wired correctly
Reduced holding force	Poor contact between electromagnet and armature plate	Make sure the lock switch is wired correctly.
		Make sure the electromagnet and armature plate are properly aligned
		Make sure the contact surfaces of the electromagnet and armature plate are clean and free from dust
	Low voltage or incorrect voltage setting	Ensure the electromagnetic lock is set for the correct voltage.
Sensor output is not functioning	A secondary diode was installed across the electromagnet	Remove any diode installed across the magnet for "spike" suppression. (The magnet is fitted with a metal oxide varistor to prevent back EMF)
	Misalignment between the reed switch and its magnet	Check the installation of armature with supplied template.

## TEMPLATE FOR MINI MAGNET

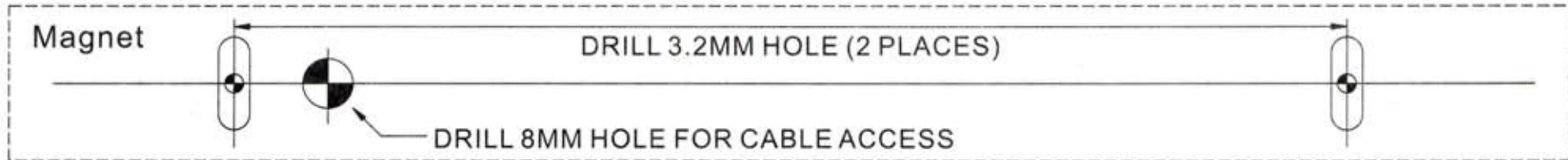

***Place again header***

**FOLD ON DOTTED LINE**

**FOLD ON DOTTED LINE**

